

Fig.1

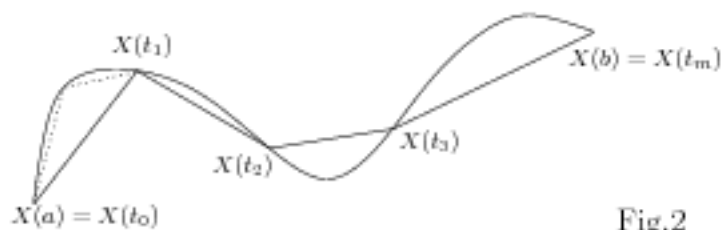


Fig.2

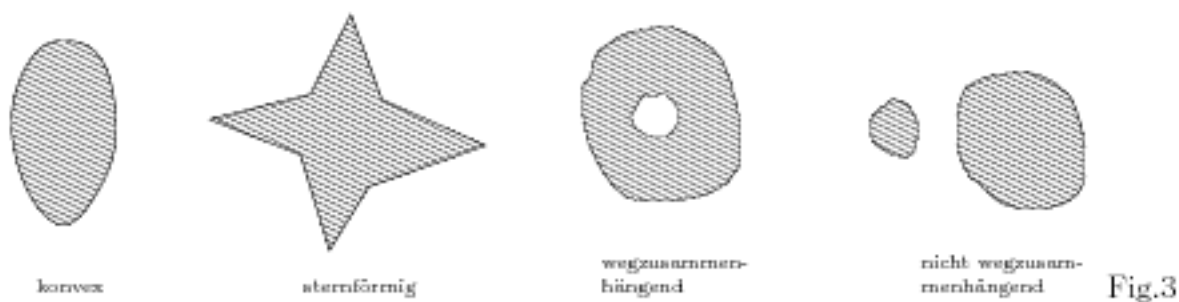


Fig.3

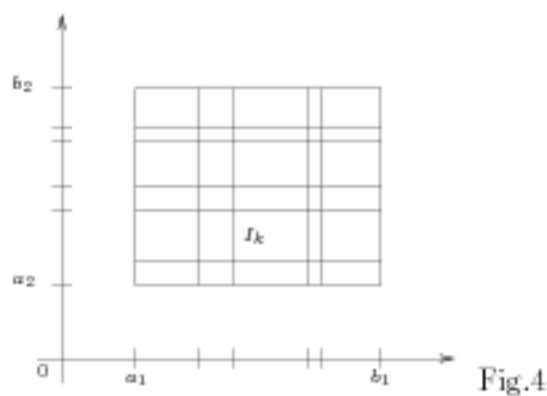


Fig.4

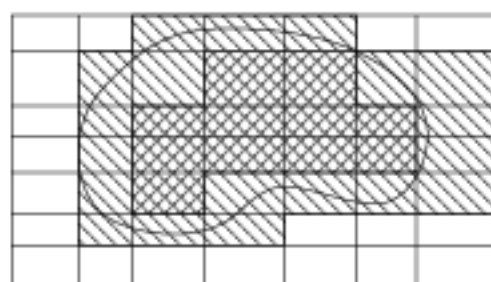

 $\square O(Z, \chi_B)$
 $\square U(Z, \chi_B)$

Fig.5

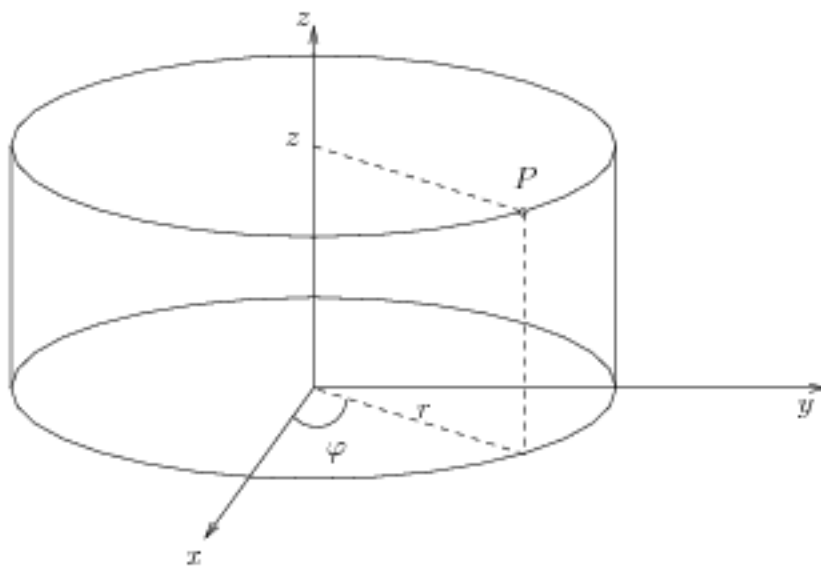
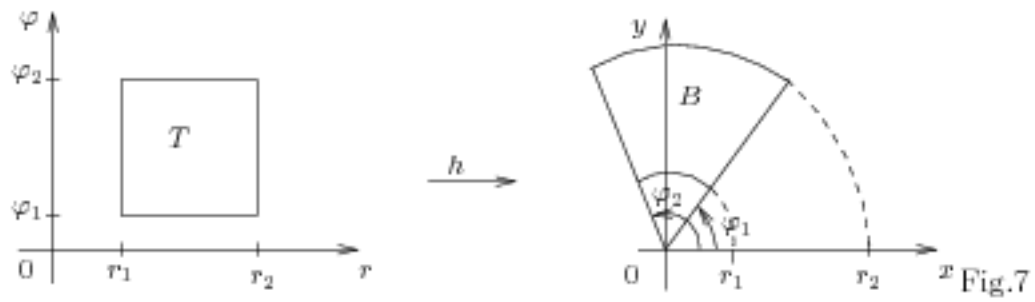
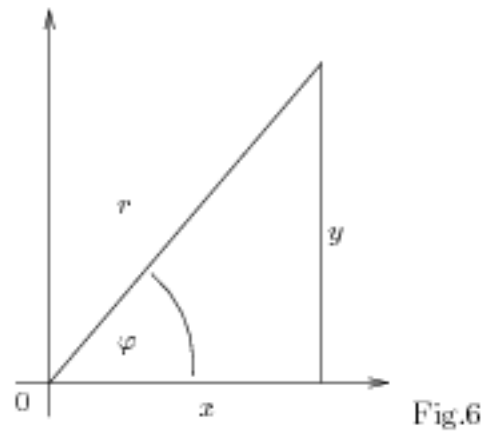


Fig.8

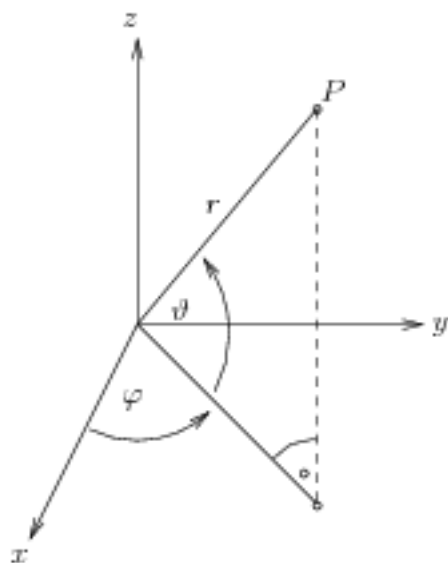


Fig.9

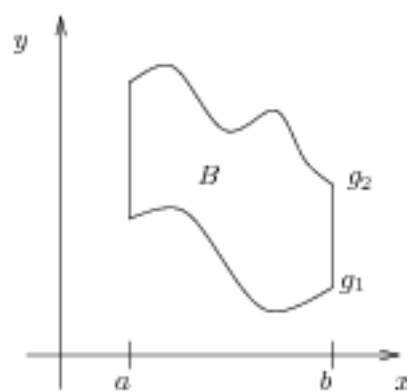
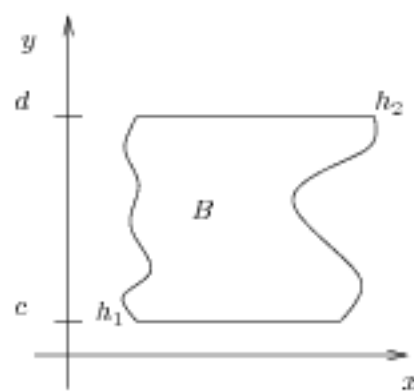
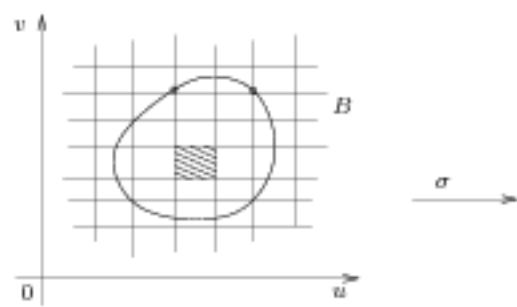
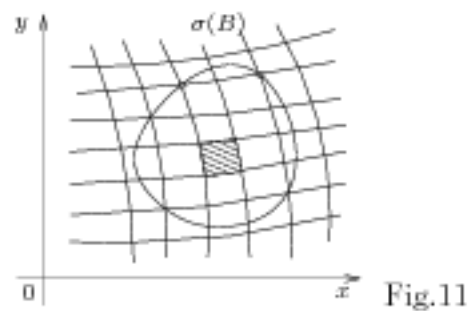
Normalbereich bzgl. x -AchseNormalbereich bzgl. y -Achse Fig.10 σ 

Fig.11

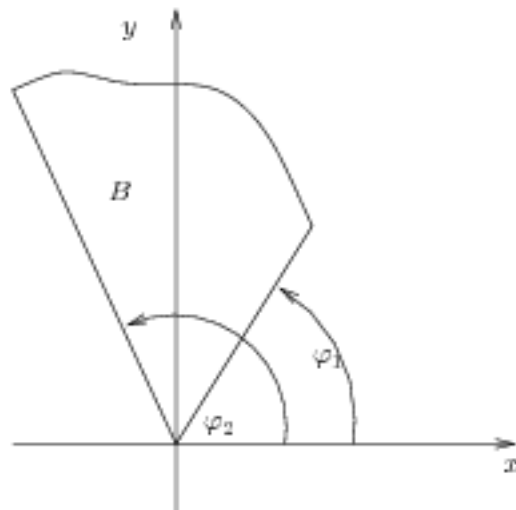


Fig.12

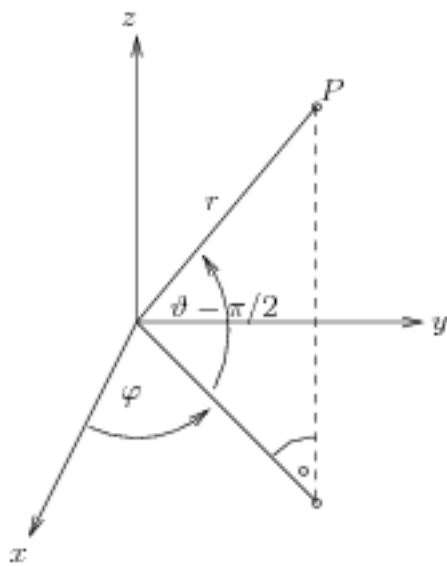


Fig.13

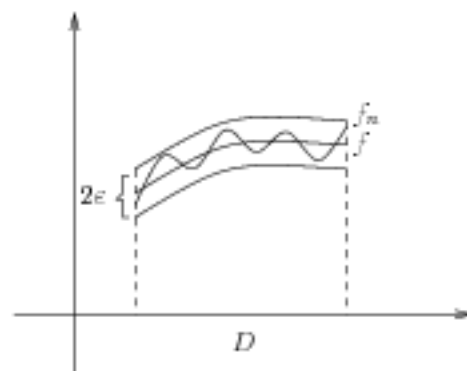


Fig.14